







Hardware Installation Guide Gigabit Ethernet PoE Injector

IE-INJ-EL02-2GTPoE (Part No. 2682440000)

1. Introduction

This PoE injector is an IEEE 802.3af/at compliant device and provides 2 independent 10/100/1000Base-T(X) PoE output ports. It is designed with a very compact and robust housing to be used in harsh industrial environments. To ensure reliable, error-free operation, and to prevent damage or injury, please read the operating instructions, all safety information provided in this document and any other safety information that were supplied with the product.

2. Safety notice

	Switch off the electrical power before removing the power connection!
	The device heats up during operation. Allow the unit to cool down or use protection gloves when carrying out any work.
	The device may only be connected to the supply voltage shown on the product label. Higher voltage than specified will destroy the device. The device must be supplied by a SELV source as defined in the Low Voltage Directive 2014/35/EU and 2014/30/EU.
	Installation, commissioning and maintenance may only be performed by qualified electricians.
	Observe the operating instructions.
	<ul style="list-style-type: none"> Indoor use and pollution degree II, it must be wiped with a dry cloth for clean up the device and label. Utilisation en intérieur et degré de pollution II, il faut l'essuyer avec un chiffon sec pour nettoyer l'appareil et son étiquette. Do not block air ventilation holes. Ne blochez pas les orifices de ventilation. If the equipment is used in a manner not specified by the manufacturer, the protection provided by the equipment may be impaired. Si l'appareil est utilisé d'une manière non spécifiée par le fabricant, la protection qu'il apporte peut se voir diminuée. Shall be mounted in the Industrial Control Panel and ambient temperature is not exceed 75 degrees C. Doit être monté dans le panneau de commande industriel et la température ambiante ne doit pas dépasser 75 degrés C.

Intended use

The device is intended for the realization of communication networks within an industrial environment, it is intended to be used in a restricted access location. The device may only be used within the scope of the specified technical data. The device is intended to be mounted to a well-grounded mounting surface, such as a metal panel. Any other use may result in unintentional malfunction and damage. Observing the documentation is part of the intended use.

Environmental conditions

This equipment is intended to be used in a restricted access location. When planning the installation site make sure that the ambient temperature during operation will not exceed the temperature given in the technical data. Also make sure that the air flow will not be compromised by other devices. Ensure that the mounted and wired device is not exposed to any mechanical stress.

FCC compliance

This device complies with part 15 of FCC Rules. Operation is subject to the following two conditions: (1) This device may not cause harmful interference, and (2) this device must accept any interference received, including interference that may cause undesired operation.

3. Package Checklist

Your Ethernet PoE Injector shipped with the following items:

- Gigabit Ethernet PoE Injector
- Hardware Installation Guide (printed)
- 4-Pin Terminal connector
- Protective caps for RJ45 ports

4. Panel Layouts

IE-INJ-EL02-2GTPoE
Front Panel View

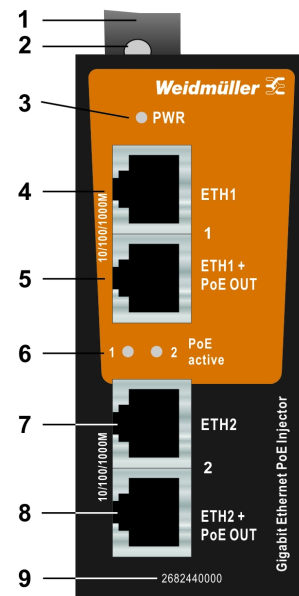

Top Panel View

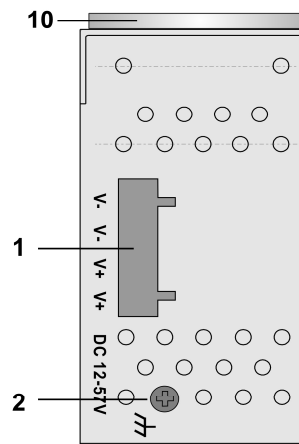

1. Terminal block for power input (PWR)
2. Grounding screw / Frame ground
(Note: The shielding ground of the LAN port is electrically connected to the grounding screw)
3. Power Input LED (PWR)
4. 10/100/1000Base-T(X) port (ETH 1 Data)
5. 10/100/1000Base-T(X) PoE port (ETH 1 Data + PoE Out)
6. LED's for PoE injection
7. 10/100/1000Base-T(X) port (ETH 2 Data)
8. 10/100/1000Base-T(X) PoE port (ETH 2 Data + PoE Out)
9. Article Number
10. DIN-Rail kit

Rear Panel View

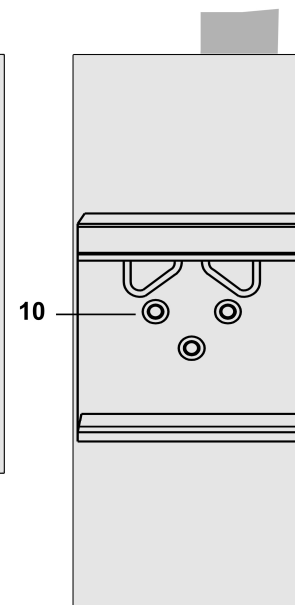

5. Mounting Dimensions

(units = mm)

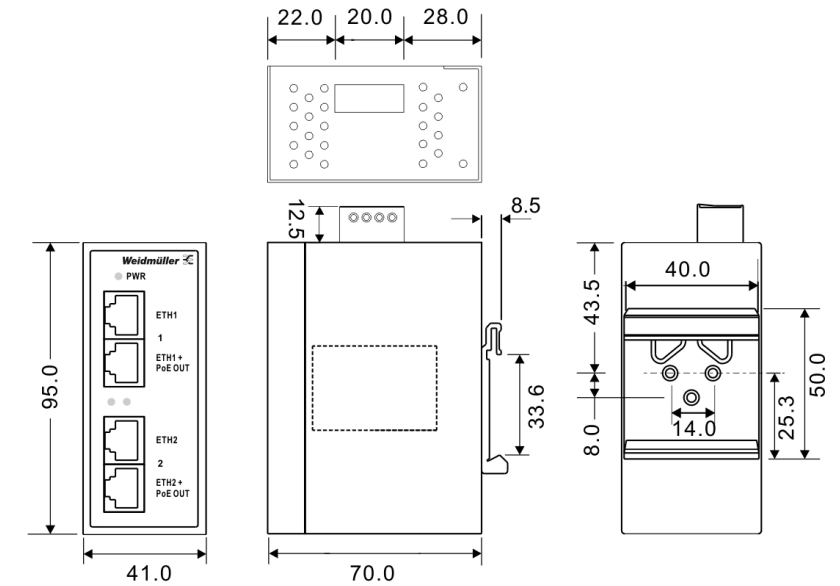

6. DIN-Rail Mounting

Slide the PoE-Injector onto a DIN-rail and make sure that the device Din-rail clip clicks into the rail firmly.

STEP 1: Insert the top of the DIN-Rail into the slot just below the stiff metal spring.

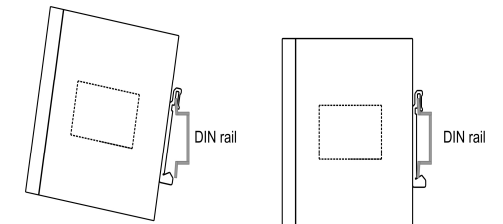

STEP 2: The DIN-Rail attachment unit will snap into place as shown below.

To remove the DIN-rail from the PoE-Injector, simply reverse Steps 1 and 2.

7. Grounding the Ethernet PoE-Injector

	ATTENTION
	- Grounding and wire routing help limit the effects of noise due to electromagnetic interference (EMI).
	- the ground connection from the ground screw to the grounding surface prior to connecting devices.
	- This product is intended to be mounted to a well-grounded mounting surface, such as a metal panel.
	- The shielding ground of the RJ45 ports are electrically connected to the ground connection (screw).

8. Power Input Wiring

The PoE Injector supports a single power supply input via the 4-pin terminal located on top side of the device. For each power input V+ and V- there are 2 internally connected pins available. Refer to illustration below for correct wiring.



Warning / Avertissement

- Take into consideration the following guidelines before wiring the device
 - Tenez compte des directrices suivantes avant de câbler l'appareil.
 - Terminal block is mating with Plug and suitable for 12-24AWG (15A). Torque value 4.5 lb-in.
 - Le bornier est compatible avec les connecteurs et convient pour 12-24AWG (15A). Valeur de couple 4,5 lb-in.
 - The temperature rating of the input connection cable should higher than 105°C.
 - La température de service nominale du câble d'entrée doit être supérieure à 105 °C.
 - Supplied by SELV source evaluated by UL 61010-1 or 61010-2-201 power supply only.
 - Fourni par la source SELV évaluée uniquement par l'alimentation UL 61010-1 or 61010-2-201.

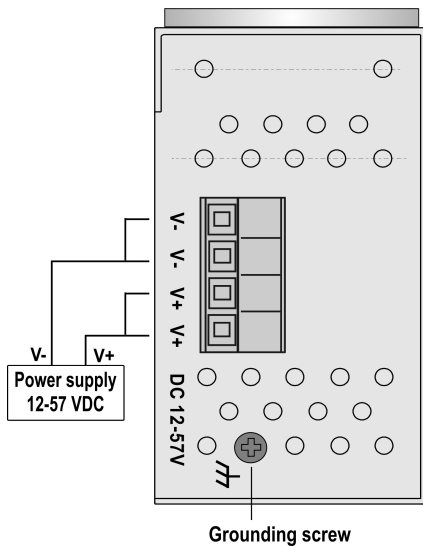

9. Communication Connections

The PoE Injector is equipped with the following Ethernet interfaces:
 2 x 10/100/1000 Base-T(X) ports
 2 x 10/100/1000 Base-T(X) PoE ports (P.S.E)

Both port groups (Eth 1 and Eth 2) are working completely independent from each other. By design the device behaves as being 2 x 1-Port-PoE-Injectors.

Please only use cables suitable for the respective type of communication and ensure that signals are protected from possible interference.

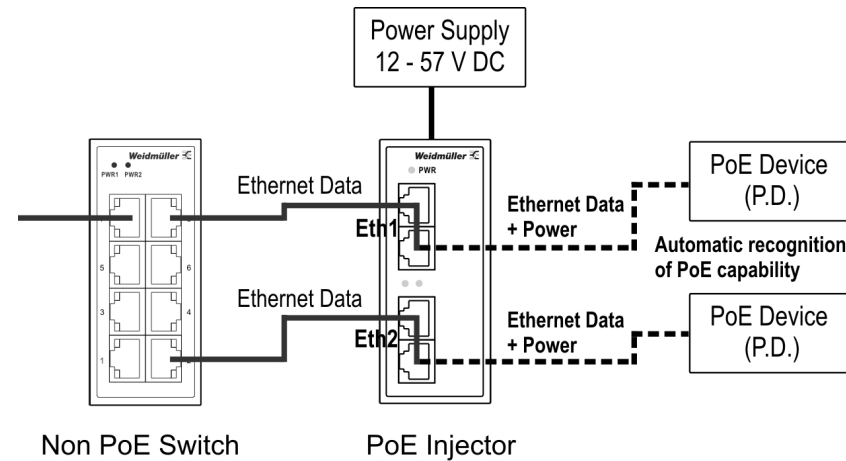

9.1 10/100/1000Base T(X) PoE Ports (P.S.E.)

In case of active PoE sourcing the Injector uses the pinout of "Alternative A, MDI-X mode" of 802.3af/802.3at standards. Please see the details in the following tables.

For pin assignments for different types of cables, please refer to the following tables.

Pinout for 10/100Base-T(X)

RJ-45 Input (Data Only)			RJ-45 Output (Data and PoE Power)	
Pin No.	Symbol	Description	Symbol	Description
1	RX+	Data Receive	RX+ (Vdc+)	Data Receive and Feeding power (+)
2	RX-	Data Receive	RX- (Vdc+)	Data Receive and Feeding power (+)
3	TX+	Data Transmit	TX+ (Vdc-)	Data Transmit and Feeding power (-)
4	NC	Not connected	NC	Not connected
5	NC	Not connected	NC	Not connected
6	TX-	Data Transmit	TX- (Vdc-)	Data Transmit and Feeding power (-)
7	NC	Not connected	NC	Not connected
8	NC	Not connected	NC	Not connected

Pinout for 100Base-T

RJ-45 Input (Data Only)			RJ-45 Output (Data and PoE Power)	
Pin No.	Symbol	Description	Symbol	Description
1	BI_DA+	Data BI_DA+	BI_DA+ (Vdc+)	Data BI_DA+ and Feeding power (+)
2	BI_DA-	Date BI_DA-	BI_DA- (Vdc+)	Date BI_DA- and Feeding power (+)
3	BI_DB+	Data BI_DB+	BI_DB+ (Vdc-)	Data BI_DB+ and Feeding power (-)
4	BI_DC+	Data BI_DC+	BI_DC+	Data BI_DC+
5	BI_DC-	Data BI_DC-	BI_DC-	Data BI_DC-
6	BI_DB-	Data BI_DB-	BI_DB- (Vdc-)	Data BI_DB- and Feeding power (-)
7	BI_DD+	Data BI_DD+	BI_DD+	Data BI_DD+
8	BI_DD-	Data BI_DD-	BI_DD-	Data BI_DD-

10. LED Indicators

The front panel of the Ethernet PoE Injector contains following LED indicators:

LED	Color	Status	Description
PWR	Green	On	Power is being supplied to power input.
		Off	Power is not being supplied.
PoE active	Blue	On	PoE injection is active.
		Off	No PoE device connected.

11. Specifications

Technology	
Standards	IEEE 802.3 for 10Base-T IEEE 802.3u for 100Base-TX IEEE 802.3ab for 1000Base-T IEEE 802.3af/at for Power over Ethernet
Interfaces	
RJ45 Ports	10/100/1000BaseT(X), auto negotiation, Full/half-duplex mode, MDI-X
LED Indicators	PWR (Power), PoE active (PoE activity/detection)
Power	
Input Voltage	12/24/48 V DC (12 - 57 V DC), 1 single input (no redundancy)
Input Current (max.)	3.12 A @ 12 VDC 2.81 A @ 24 VDC 1.30 A @ 48 VDC
Connection	One removable 4-pin terminal block, Wiring cable 12-24AWG
Overload Current Protection	Present
Reverse Polarity Protection	Present
PoE	
Total power budget	30 W @ 12-23 V DC; 60 W @ 24-57 V DC
PoE Pinout	Mode A: Pin 1, 2 (V+); Pin 3, 6 (V-); Alternative A; MDI-X
Physical Characteristics	
Housing	IP30 protection, metal
Dimension (W x H x D)	41 x 95 x 70 mm (1.61 x 2.75 x 3.74 inch)
Weight	370 g
Installation	DIN-rail
Environmental conditions	
Operating Temperature	-40 to 75°C (-40 to 167°F)
Storage Temperature	-40 to 85°C (-40 to 185°F)
Ambient Relative Humidity	5 to 95% (non-condensing)
Operating Altitude	Up to 2000 m
Regulatory Approvals	
Safety	UL 61010-1, UL 61010-2-201
EMC	EN 55032, EN 55024, FCC Part 15 Subpart B Class A, IEC 61000-4-2 ESD: Contact: 4 kV; Air: 8 kV, IEC 61000-4-3 RS: 80 MHz to 1 GHz: 3 V/m, IEC 61000-4-4 EFT: Power: 0.5 kV; Signal: 0.5 kV, IEC 61000-4-5 Surge: Power: 0.5kV; Signal: 1 kV, IEC 61000-4-6 CS: 3 Vrms
Shock	IEC 60068-2-27
Free Fall	IEC 60068-2-31
Vibration	IEC 60068-2-6
MTBF	
Time	3.165.390 hrs
Database	Telcordia SR332
Warranty	
Time Period	5 years

Contact Information

Weidmüller Interface GmbH & Co. KG
 Klingenbergstraße 26, 32758 Detmold / Germany
 Phone +49 (0) 5231 14-0, Fax +49 (0) 5231 14-292083
 E-Mail weidmueller@weidmueller.com, Internet www.weidmueller.com